

Directions and Maps

Lawrence Campus at Franklin Street

Located at 45 Franklin Street in Lawrence. From Route 495 north or south, take exit 41 (Route 28) toward Lawrence. Follow Route 28 north for 2.4 miles. Turn right on Valley Street and continue straight ahead into the campus parking lot. From Route 93 north or south, take exit 46 (Route 110). Proceed on Route 110 (which becomes Haverhill Street) toward Lawrence. Turn right on Route 28 and take the fourth left onto Valley Street. Continue straight ahead into the campus parking lot.

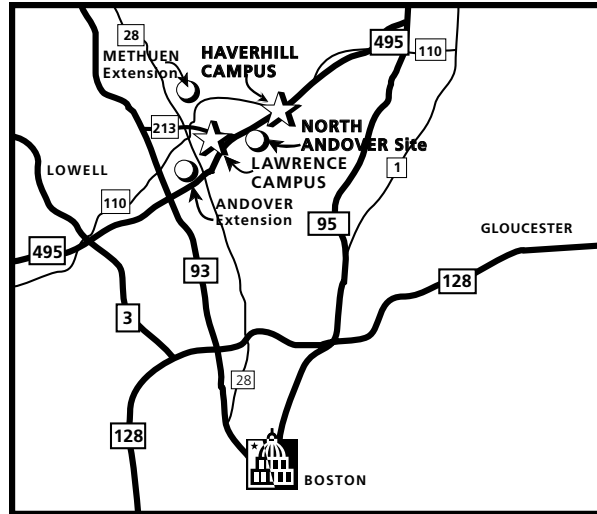

Lawrence Campus at Amesbury Street

Located at 78-82 Amesbury St. in Lawrence. From Route 495 north or south, take Exit 41 (Route 28) toward Lawrence. Follow Route 28 north for 2.4 miles. Turn right on Lowell Street. Proceed to Amesbury Street (3 blocks), turn right on Amesbury Street. The first entrance on the right is the college parking lot. From Route 93 north or south, take Exit 46 (Route 110). Proceed on Route 110 (which becomes Haverhill Street) toward Lawrence. Cross Route 28 (Broadway), proceed to the 3rd traffic light. Turn right onto Amesbury Street. After the first set of lights, turn right. The college parking lot entrance will be the first turn on the right. Additional parking is available in the Buckley Garage across from the campus.

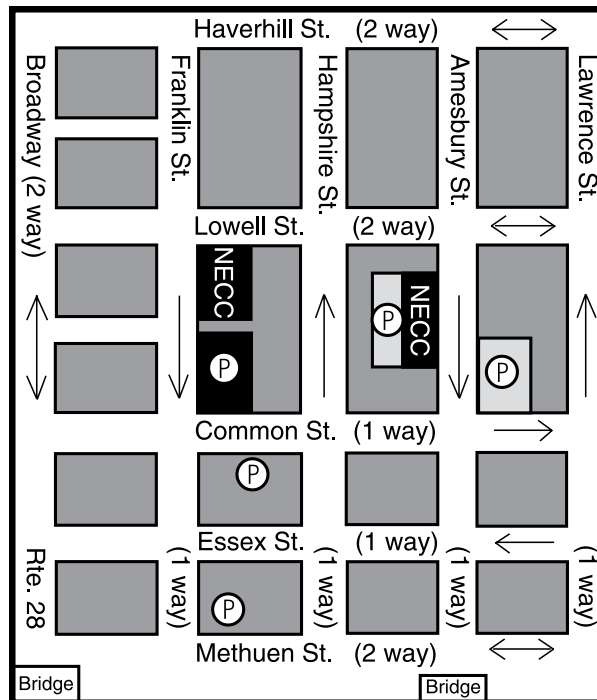

200909-002

Northern Essex Community College
 100 Elliott Street
 Haverhill MA 01830
 Office of Facilities Coordinator

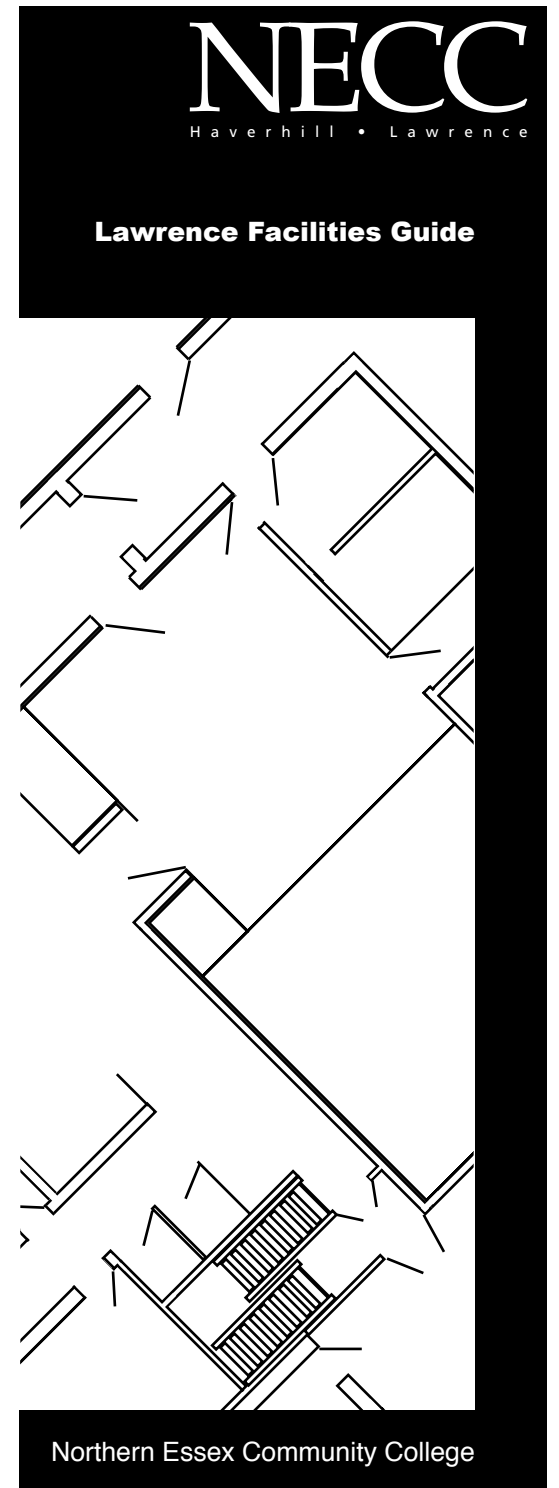

Amesbury Street Campus

Entrance Level

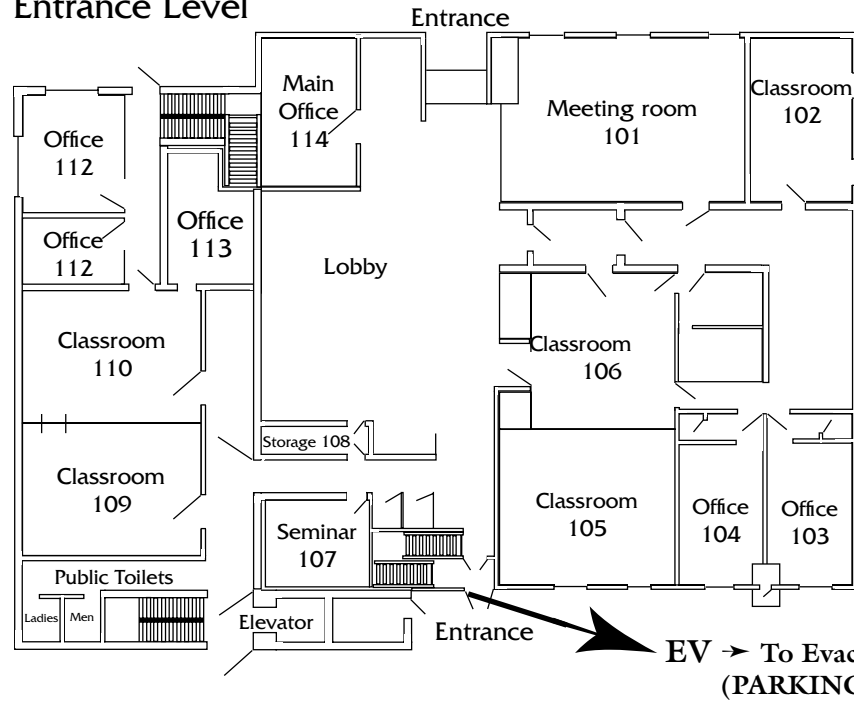

Room Location	Capacity
Conference Rooms	
Room 101	80
Room 107	10

PARKING AREAS

Lower Level

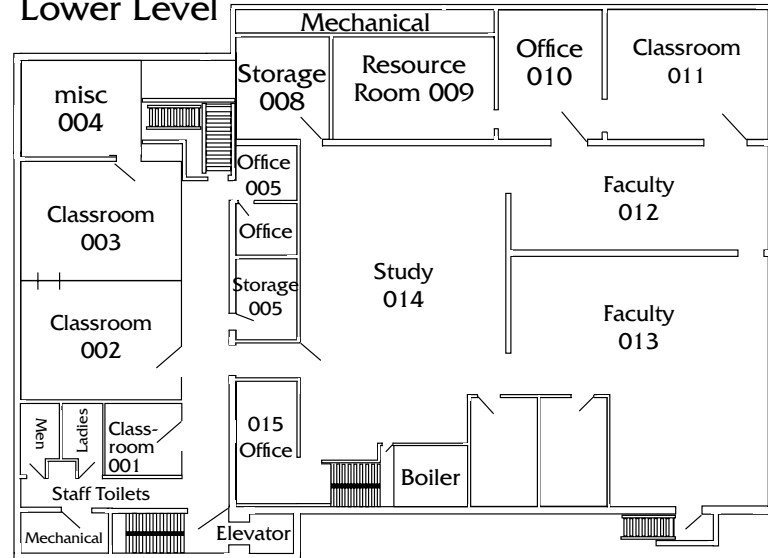

Upper Level

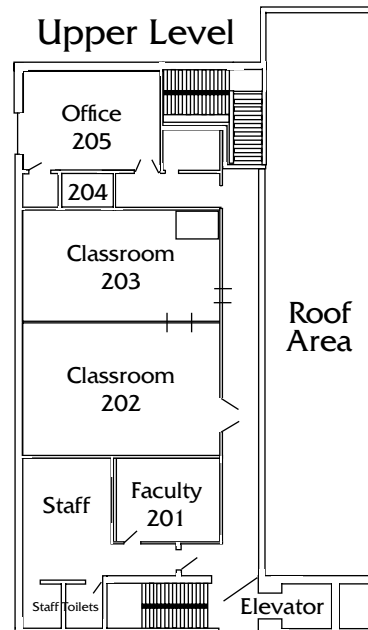

Franklin Street Campus - John R. Dimitry Building

First Floor Reception and Conference Rooms

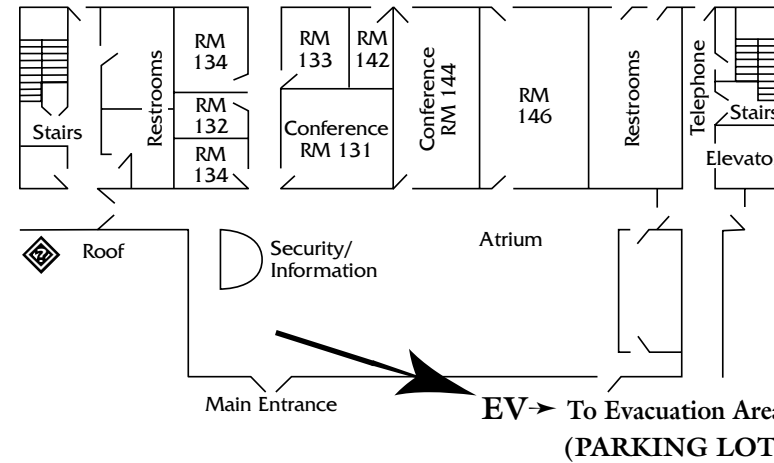

Room Location	Capacity
Atrium	
Reception	80
Conference Rooms	
Room 131	14
Room 144	25
Room 253	10
Room 244	60

For more information:
 Facilities Rental
 978-556-3224

Other important numbers:
 Lawrence Campus Number
 978-738-7000
 Emergency School Closing
 978-556-3002
 In Case of Emergency
 978-738-7499
 TTY
 978-738-7475
Catering Services
 978-374-1345 • 978-556-3975

Second Floor Lecture and Conference Rooms

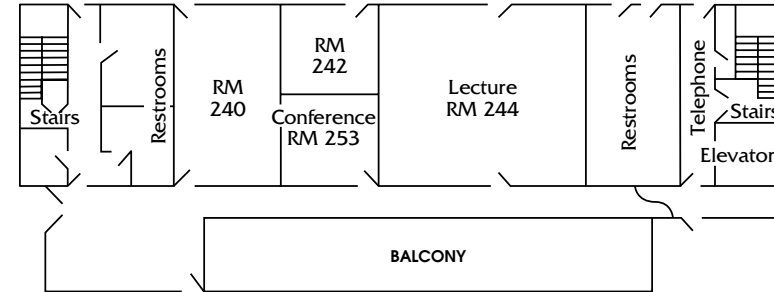





PARKING INFORMATION

All vehicles must be parked in an appropriate area. Parking lot designations apply in accessible spaces. Campus parking lots fill up early. Additional parking is available at the Common Street Parking Lot and the Buckley Transportation Garage. For free parking, parking tickets MUST be validated by NECC Security at the main security desks at the Franklin Street and Amesbury Street locations.



General Information

-  All college facilities are wheelchair accessible.
-  Both Lawrence campuses are TTY accessible.
-  All campuses are smoke-free.
-  All campuses have a "No Tolerance Alcohol" policy.
-  No animals are allowed on college property except for guide dogs or other services animals.